

F108D User Manual



Statement

The copyright of this manual belongs to Shenzhen JIEHE Technology Development Co., Ltd. (Giada, JIEHE's global brand) and all rights are reserved. The company reserves the right to change this manual at any time without notification. Specifications here are for reference only, please take the real product as standard.

Without official authorization of Giada, other company or individual may not copy, plagiarize, translate or disseminate this manual for commercial purpose.

The information provided in this manual is accurate and reliable. The company does not take any legal responsibility for the consequences of infringement use of this manual.

Safety Notice

- Read the user manual carefully before setting up the Giada product.
- Disconnect the power cord before installing the internal components
- Most electronic components are sensitive to static electrical charge, please wear a wrist-grounding strap when installing the internal components.
- Don't disconnect the power cord when the system is running to avoid damage to the sensitive components caused by instantaneous surge voltage.

Contact Information

Shenzhen JIEHE Technology Development Co., Ltd.

Website: www.giadatech.com

Phone: +86-755-3330 0336

Email: support@giadatech.com

Address: 1~2/F, Block A, Tsinghua Information Harbor, North Section, Shenzhen Hi-tech Park, Nanshan District, Shenzhen, China

Table of Contents

1. Product Introduction	5
2. Interface Description and Hardware Specifications	5
2.1 Interface Description	5
2.2 Hardware Specifications	6
3. Accessories Installation Steps	8
3.1 Memory Installation	9
3.2 SIM Card Installation	9
3.3 3G/4G Installation	10
3.4 SSD(M.2) Installation	11
3.5 WIFI(M.2) Installation	12
4. BIOS Setup	13
4.1 Main (Standard CMOS) Setup	16
4.2 Advanced BIOS Setup	17
4.2.1 ACPI Setup	17
4.2.2 CPU Configuration	18
4.2.3 Wake Computing	20
4.2.4 Trusted Computing	22
4.2.5 HW Monitor & Smart fan	24

4.2.6 System Devices Configuration	26
4.3 Security Setup	27
4.4 Boot Menu.....	29
4.5 Save & Exit	30
5. JAHC Introduction	31
5.1 Auto Power on	31
5.2 JAHC Software	33
5.2.1 JAHC Software Functions	33
5.2.2 JAHC Software Installation Guide	33
5.2.3 Startup and Shutdown Time Setup	37
5.3 Watchdog API and Instruction	38

1. Product Introduction

Based on Intel® Alder Lake-N platform, Giada F018D offers both fan and fanless design options. The standard version is fanless, while the picture in the manual shows the fan design. It features with dual LAN ports and dual COM ports. With one DP and two HDMI displays output, it can support 4K 60Hz display. The player is suitable to be applied in mainstream digital signage applications.

2. Interface Description and Hardware Specifications

2.1 Interface Description

Front I/O Port

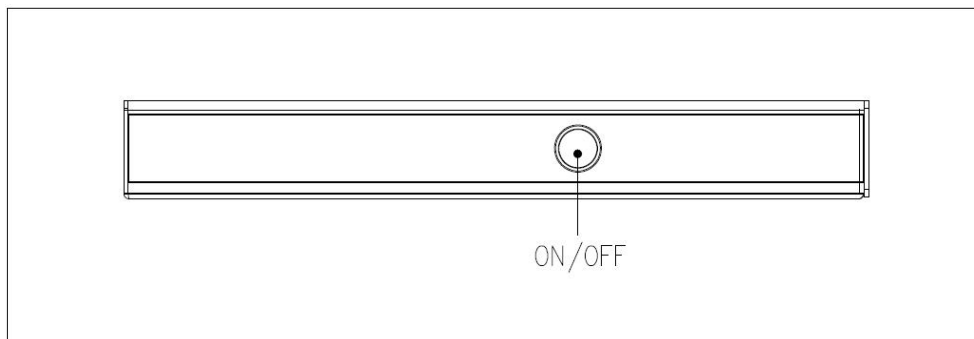

Left I/O Port

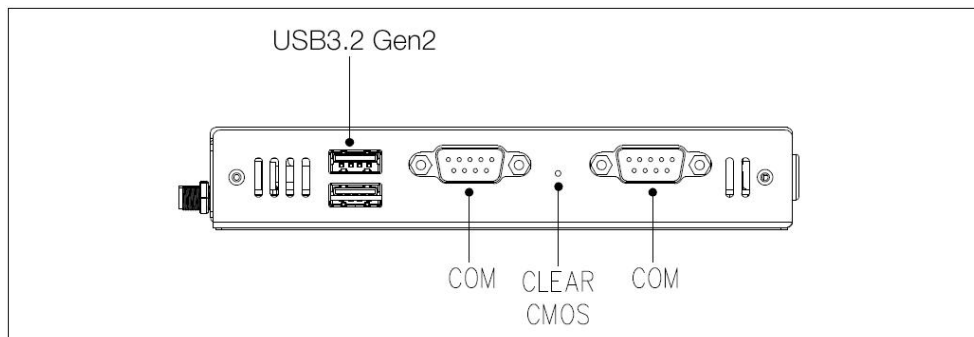

Rear I/O Port

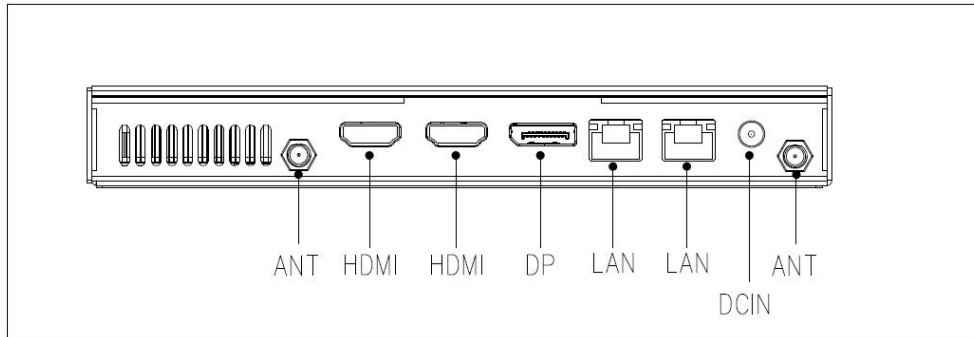

Right I/O port

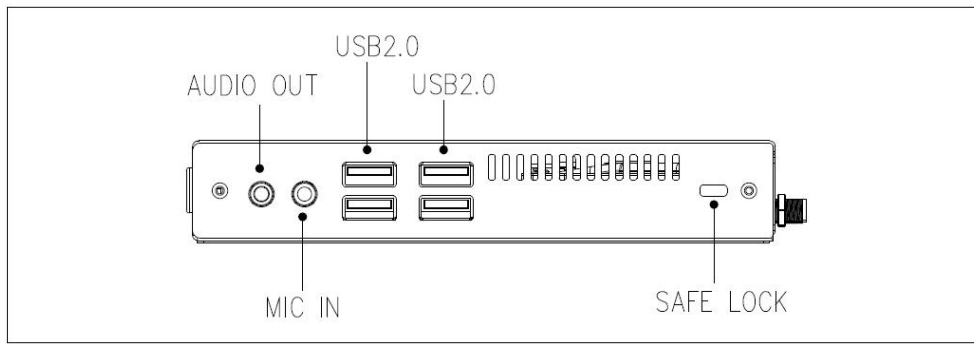

2.2 Hardware Specifications

F108D		F108D-FV-N10040N0G-GIA	F108D-NU-N9540N0G-GIA
Processor	CPU	Intel® Processor N100 (Fanless)	Intel® Processor N95
	Frequency	3.40 GHz	3.40 GHz
	BIOS	AMI Source Code	
	Chipset	SOC	
Memory	Type	DDR4-3200 MHz	
	Socket	1 x SO-DIMM	
	Max Capacity	Up to 16 GB	
Graphics	GPU	Intel® UHD Graphics	
	Graphic Engine	DirectX 12.1, OpenGL 4.6, OpenCL 3.0	
	Display Interface	1 x DP (Max.4096 x 2160 @60Hz) 2 x HDMI (Max.4096 x 2160 @60Hz)	

Network	Controller	2 x Realtek RTL 8111H Gigabit Ethernet
	Interface	2 x RJ45 (Optional: 1 x RJ45)
	Wi-Fi/BT	1 x E-Key M.2 (2230) for Wi-Fi/BT, Support Wi-Fi 5, Wi-Fi 6
	Mobile Network	1 x B-Key M.2 (3042) for 3G/4G 1 x SIM Slot
I/O Interface	USB	2 x USB3.2 Gen2, 4 x USB2.0
	Serial Port	2 x RS232
	Audio	1 x MIC-IN, 1 x AUDIO-OUT
	Button	1 x Power on, 1 x CLR-CMOS
	Antenna	2 x Connector for Wi-Fi/BT
Storage	M.2 (2280)	1 x M-Key M.2 (2280) for PCIe3.0 X4 SSD
JAHC	JAHC	Watchdog Timer / Auto Power On / RTC
Operation System	OS	Windows 11 (64bit) Linux Ubuntu (64bit)
Power	Power Type	DC-IN
	Input Voltage	19 V/2.37 A
Mechanical	Construction	Metal
	Mounting	VESA Mounting Kit (JZ183)
	Dimension (W x D x H)	189.6mm x 148.3mm x 26mm (7.46" x 5.83" x 1.02")
	Color	Black
Environment	Operating Temperature	0°C ~45°C (32°F~113°F) @0.7m/s Air Flow
	Relative Humidity	95%@40°C (non-condensing)
Certification		CE, FCC Class B, UKCA

3. Accessories Installation Steps

▲ For safety reasons, please ensure that the power cord is disconnected before opening the case.

How to open the top cover and bottom cover

Unscrew the four screws and open the top case. (1 x M-Key M.2 (2280) for SSD, 1 x B-Key M.2 (3042) for 3G/4G, 1 x SIM Slot, 1 x E-Key M.2 (2230) for Wi-Fi/BT are on top side).

Unscrew the four screws, push the bottom cover and remove it. (1 x SO-DIMM DDR4 is on bottom side).



3.1 Memory Installation

▲ This product only supports DDR4 SO-DIMM memory modules.

1. Locate the SO-DIMM slot on the board.
2. Gently insert the module into the slot at a 45-degree angle.
3. Carefully push down the memory module until it snaps into the locking mechanism.



3.2 SIM Card Installation

▲ This product supports standard SIM card with the size of 25mm × 15mm.

1. [Open] the SIM card holder and pull it up.
2. Insert the SIM card.
3. [Lock] the card holder.

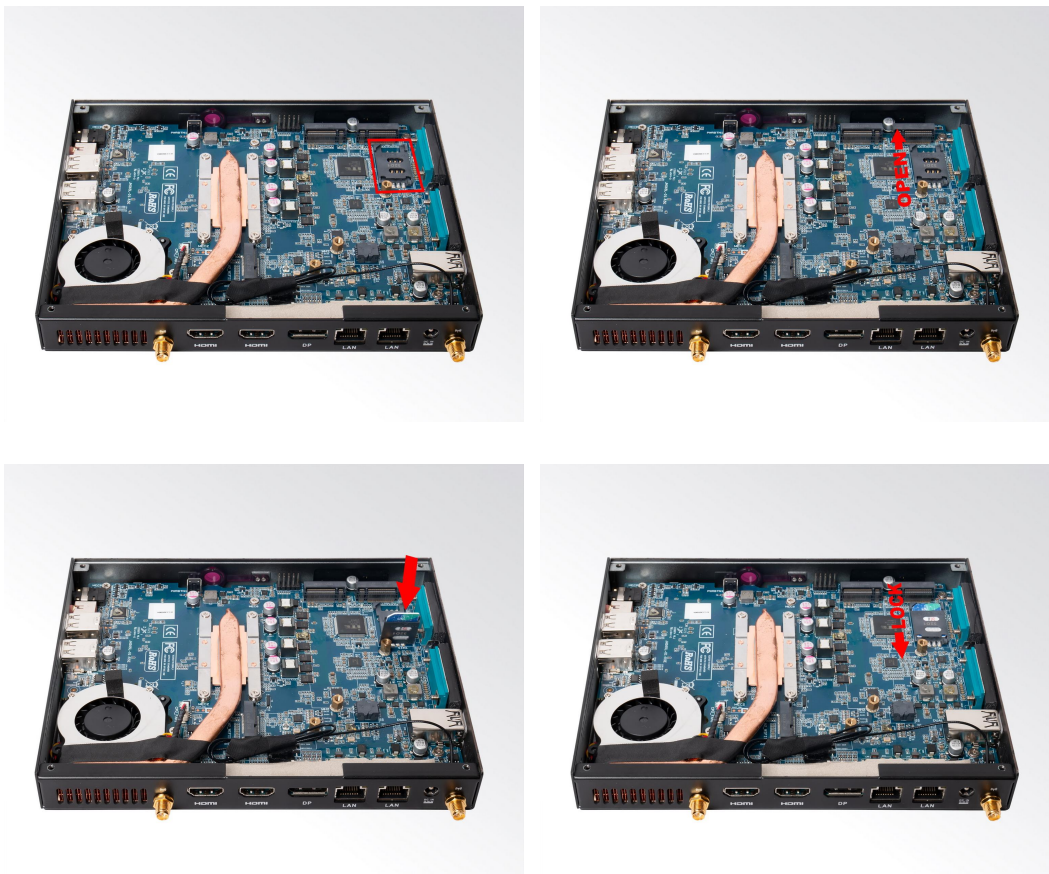

3.3 3G/4G Installation

● 3G/4G Installation

▲ Default external antennas are for WIFI. Please change one external antenna for 3G/4G.

1. Plug the 3G/4G module into the M.2 slot.
2. Secure the module to the standoff screw by tightening up the screw.
3. Connect the cable to **Main** and install the antenna.





3.4 SSD (M.2) Installation

1. Plug the SSD (M.2) into the appropriate slot.
2. Secure the module to the carrier by tightening up the screw.

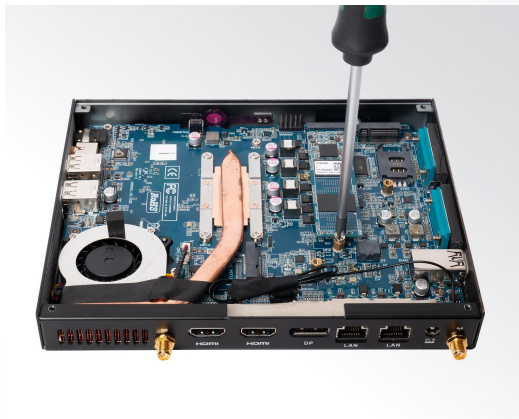

3.5 WIFI (M.2) Installation

1. Plug the WIFI module into the appropriate slot.
2. Secure the module to the carrier by tightening up the screw.
3. Connect the two cables to WIFI module and install the antennas.

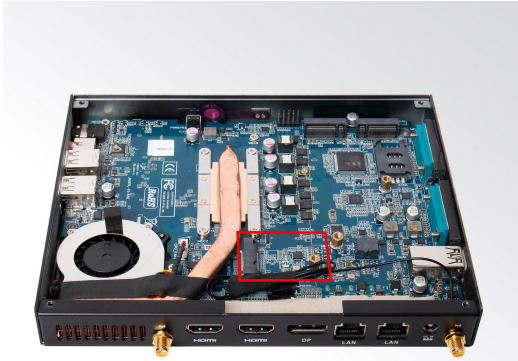

4. BIOS Setup

Notice:

The descriptions relating to BIOS setup in this Manual is for reference only when the BIOS version of the product might be upgraded. Giada provides no guarantee that all the contents in this Manual are consistent with the information you acquired.

BIOS is a basic I/O control program saved in the Flash Memory. Bridging the motherboard and the operation system, BIOS is used for managing the setup of the related parameters between them.

When the computer is activated, the system is first controlled by the BIOS program. Firstly, a self-detection called POST is performed to check all hard devices and confirm the parameters of the synchronous hardware.

Once all detections are completed, BIOS will hand over the controlling to the operation system (OS). As BIOS serves as the only channel that connects the hardware and software, whether your computer can run stably and work in optimized state will hinge on how to properly set the parameters in BIOS. Therefore, the correct setup of BIOS plays a key role for stably running the system and optimizing its performance.

The CMOS Setup will save the set parameters in the built-in CMOS SRAM on the motherboard. When the power is shut off, the lithium battery on the motherboard will provide continuously power to CMOS SRAM.

The BIOS setup program will allow you to configure the following items:

1. HD drive and peripheral devices
2. Video display type and display items
3. Password protection
4. Power management characteristics

A. State of BIOS Setup

When the computer is started up, BIOS will run the self-detection (Post) program. This program includes series of diagnosis fixed in BIOS. When this program is executed, the following information will appear if any error is found:

Press [F1] to Run General help

Press [F2] to Load previous values and continue

To enter BIOS, you can press F2 to load the default values and enter the system, you can press DEL to enter the BIOS interface if no error is found. If the indicative information disappears before you operate, you can shut off the computer and turn it on again, or you can press the RESET key on the product case. To restart your computer, you can also simultaneously press < Ctrl > + < Alt > + < Delete >.

B. Function Keys definitions

Hot Key	Description
↑	(Up key) Move to the previous item
↓	(Down key) Move to the next item
←	(Left key) Move to the left item
→	(Right key) Move to the right item
ESC	Exit the current interface
Page Up	Change the setup state, or add the values
Page Down	Change the setup state, or deduct the values
F1	Display the information of the current function Keys definitions.
F9	Load the optimized values
F10	Save the settings and exit the CMOS SETUP

C. Auxiliary information on Main interface

When the system enters the main interface of Setup, the major selected contents will be displayed at the lower part of the interface with the change of the options.

When you set the value for each column, you can view the preset value of the column and the values that can be set if you press F2, for example, the BIOS default values or CMOS Setup values. To exit the interface for auxiliary information, press [ESC].

1) Main menu

When the system enters the CMOS Setup menu, you can see the main menu on the upper part of the screen, as shown in Figure 1.

In this main menu, you can use the left and right direction keys to select the setup items.

Once the item is selected, the lower part of the computer screen will show the details of setting.

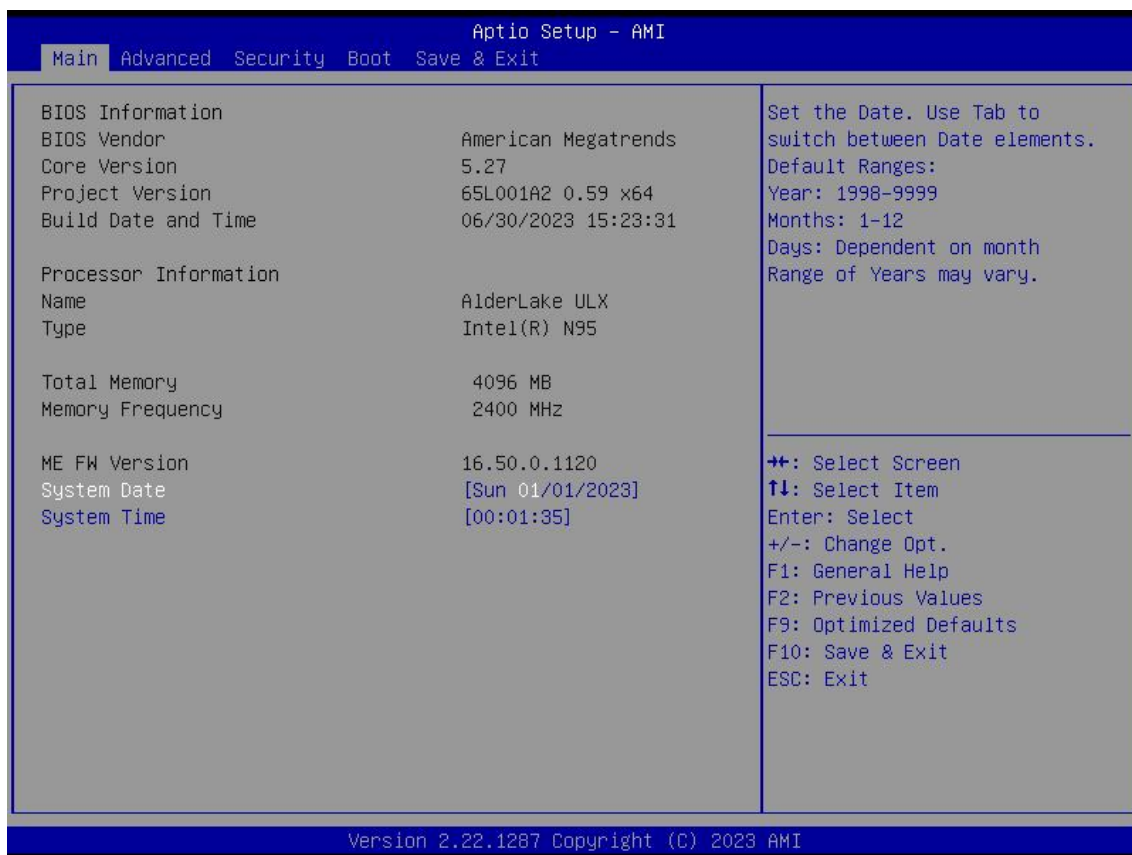

Fig 1

1) Main (standard CMOS setup)

This item is used for setting the date and time.

2) Advanced (advanced BIOS setup)

This item is used for setting the advanced functions provided by BIOS, such as specifications of PCIe facilities, CPU, HDD, etc.

3) Security (set the administrator/user password)

4) Boot (startup configuration characteristics)

5) Save & Exit (option of exit)

This item includes load optimal defaults / load failsafe defaults value / discard changes / discard changes and exit.

6) MEBx

4.1 Main (Standard CMOS setting)

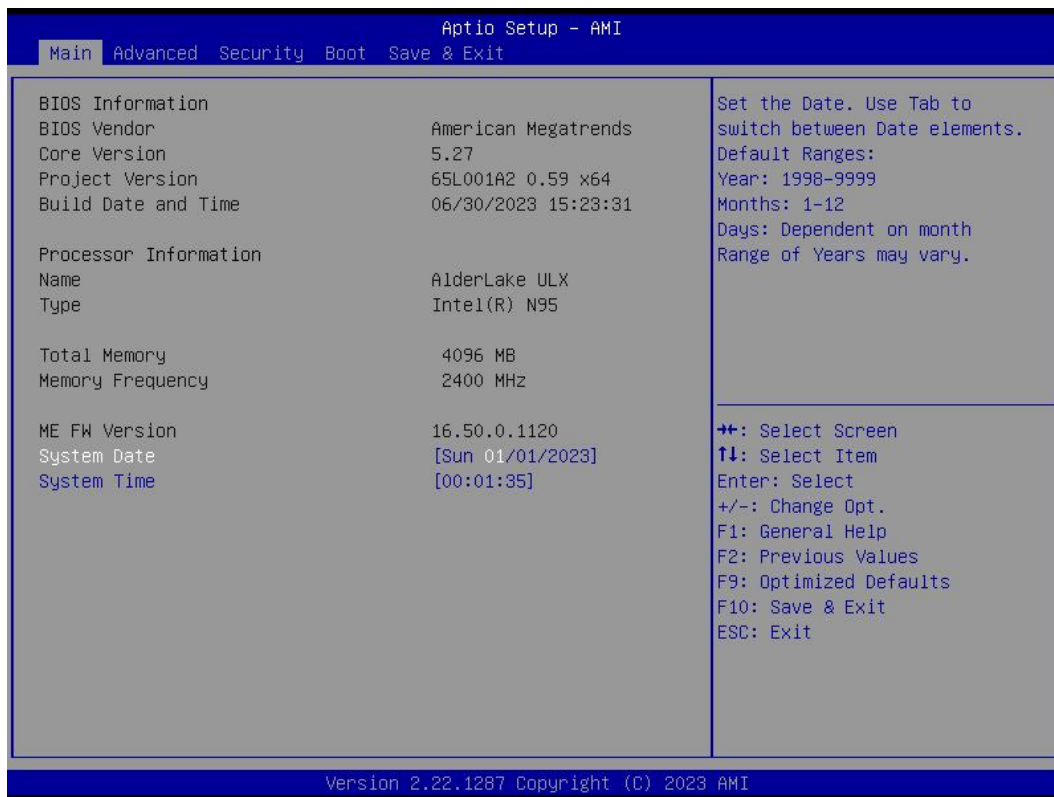

1) System time (hh:mm:ss)

Use this item to set the time for the computer, with the format as “HH / MM / SS”.

2) System date (mm:dd:yy)

Use this item to set the date for the computer, with the format as “week, MM / DD / YY”.

4.2 Advanced (Advanced BIOS setup)



4.2.1 ACPI Setting

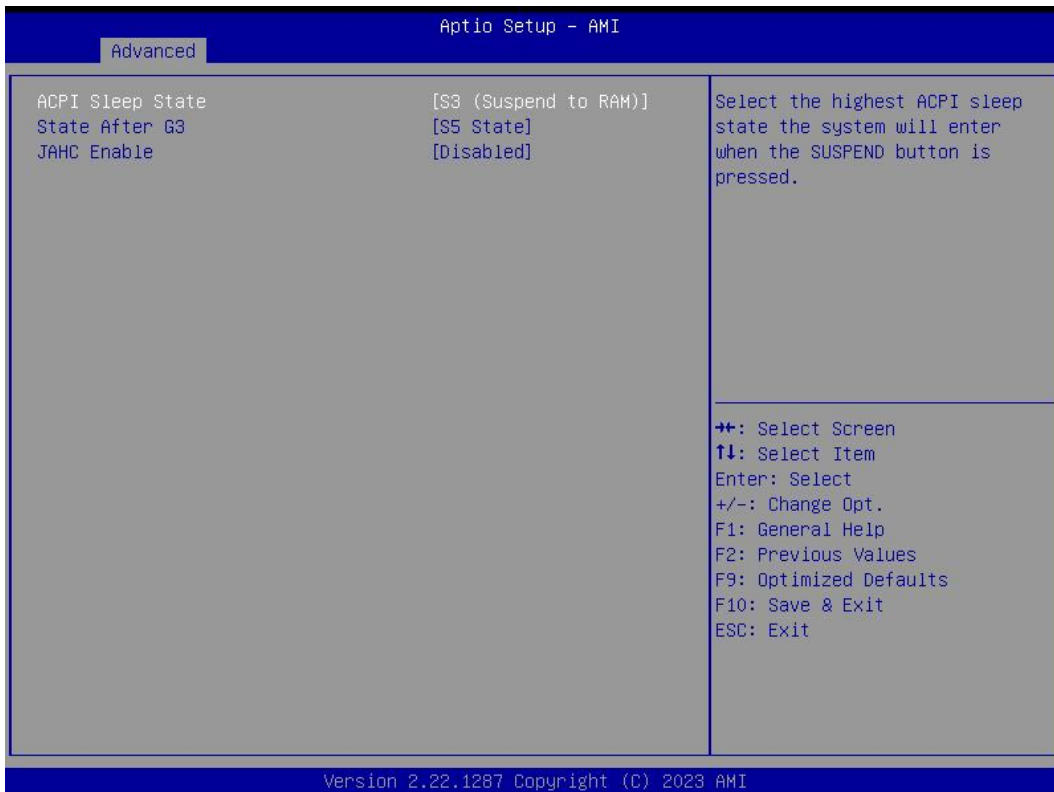

ACPI Options	Description
ACPI Sleep state	<p>You can use the ACPI Sleep state option to control system hibernation</p> <p>Suspend Disabled: Disable system Suspend.</p> <ul style="list-style-type: none"> ● S3 (Suspend to RAM): Enable S3(Suspend to RAM)
State After G3	<ul style="list-style-type: none"> ● State After G3 means after restore power supply. ● S5 State (Default): If set it as S5 State, it means the system will remain shutdown state ● S0 State: If set it as S0 State, it means the system will be power on automatically.
JAHC Enable	<p>JIEHE Active Hardware Control (JAHC) management system includes both hardware Micro Control Unit (MCU) and software (JAHC Technology Manager).</p> <ul style="list-style-type: none"> ● Disabled: The JAHC is disable by default. ● Enabled.

4.2.2 CPU Configuration

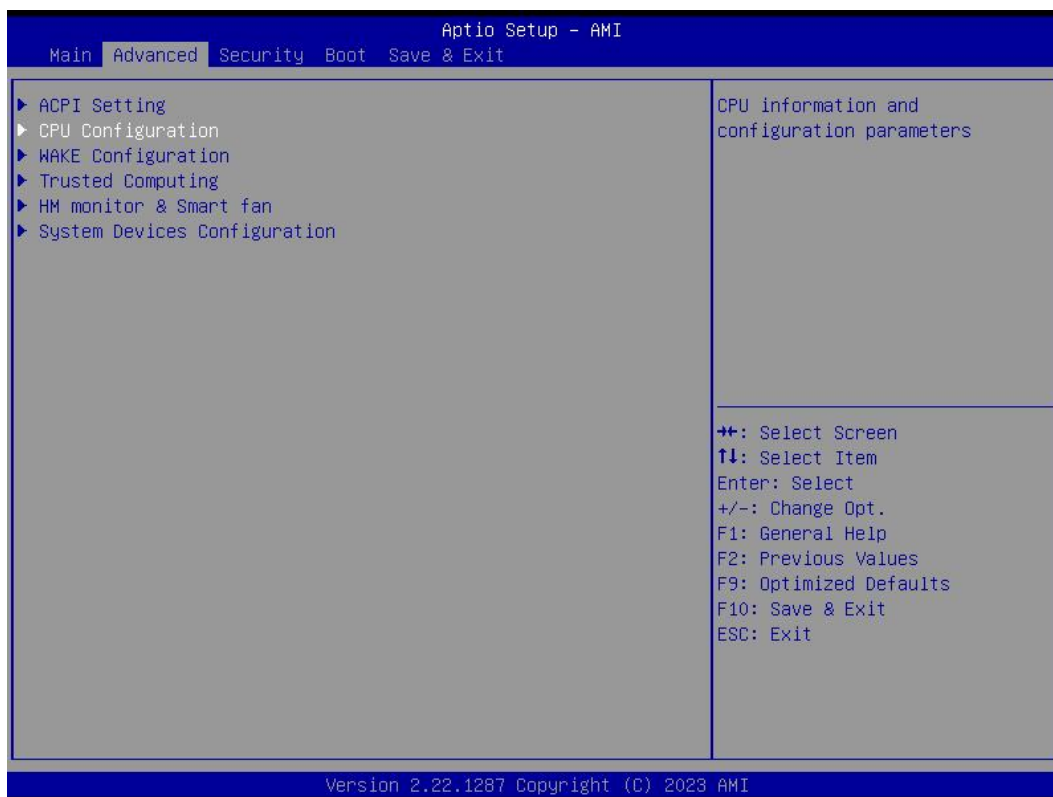

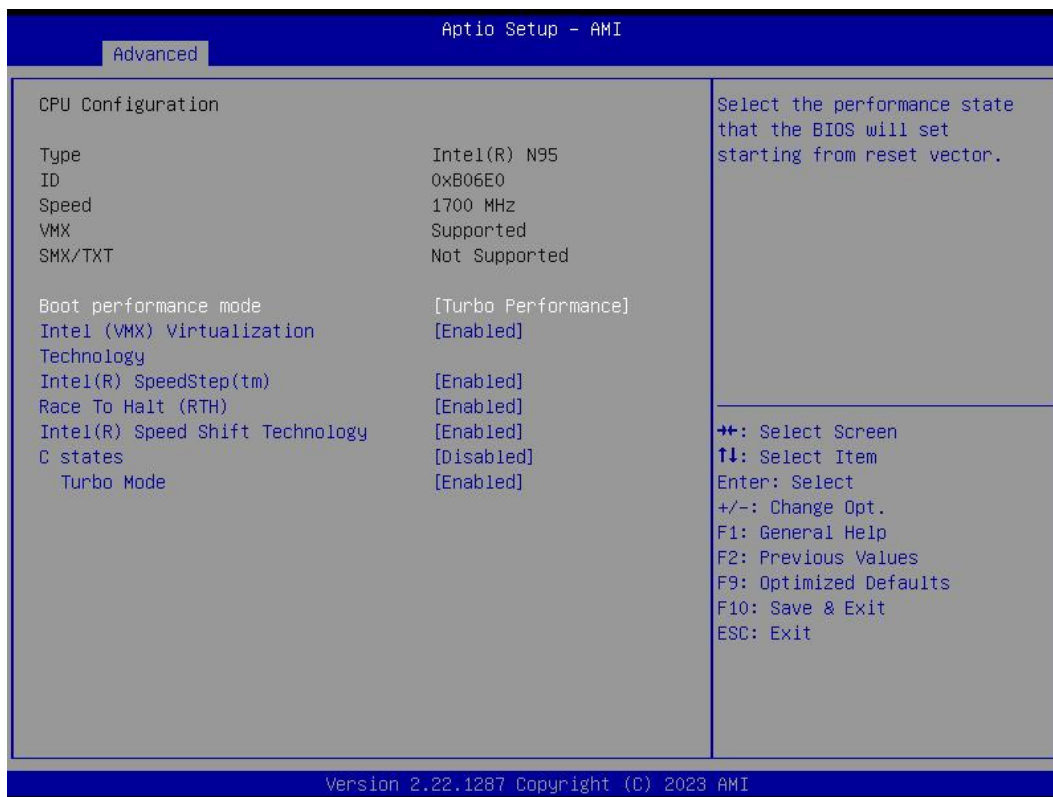

The menu	Description
CPU Configuration	
Boot performance mode	<ul style="list-style-type: none"> ● Max Non-Turbo Performance: the best performance. ● Max Battery. ● Turbo performance.
Intel (VMX) Virtualization Technology	Intel Virtualization Technology is enabled by default. User can enable and disable the Intel Virtualization Technology function.
Intel (R) Speed Step (tm)	Intel (R) Speed Step Technology dynamically increases the processor's frequency as needed by taking advantage of thermal and power headroom to give you a burst of speed when you need it, or increased energy efficiency. The option is enabled by default. You can disable the function if it's necessary.
Race To Halt (RTH)	The Race To Halt (RTH) function is enable by default. It can adjust the CPU base frequency work in C-state. Optional: C-state.

The menu	Description
Intel (R) Speed Shift Technology	Intel speed shift function is enabled by default. Intel® Speed Shift Technology uses hardware-controlled P-states to deliver dramatically quicker responsiveness with single-threaded, transient (short duration) workloads, such as web browsing, by allowing the processor to more quickly select its best operating frequency and voltage for optimal performance and power efficiency.
C states	The C-State function is disabled by default.
Turbo Mode	<ul style="list-style-type: none"> ● Disabled. ● Enabled.

4.2.3 Wake Configuration

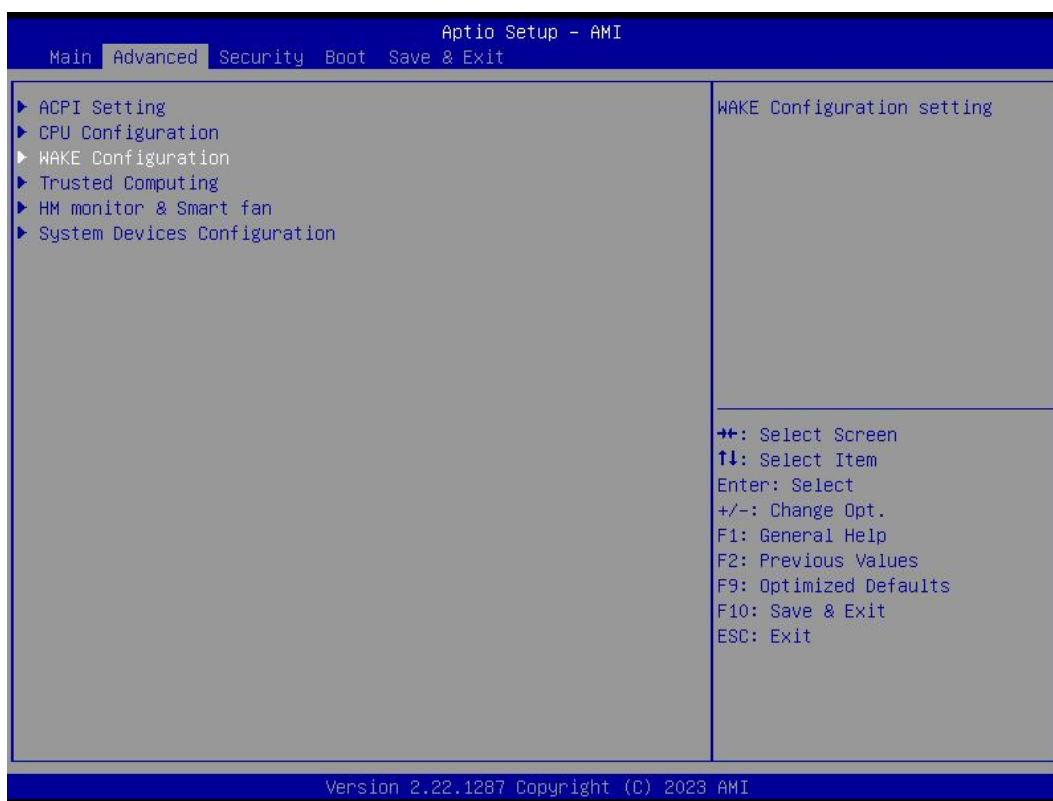

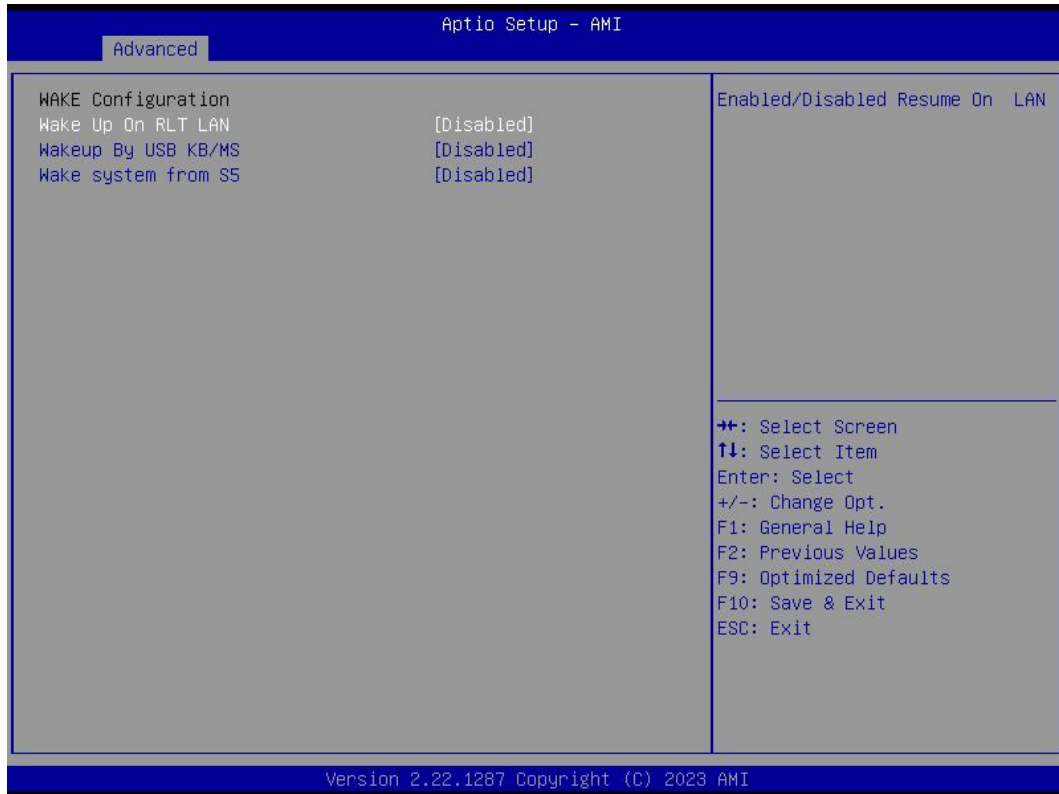

WAKE Configuration Options	Description
WAKE Configuration	
Wake Up On RLT LAN	<p>Wake On LAN Function.</p> <ul style="list-style-type: none"> ● Disabled: The WOL is disabled by default. ● Enabled.
Wake up By USB KB/MS	<ul style="list-style-type: none"> ● Enabled/Disabled Wake Up by USB KB/Mouse from S3 Status.
Wake system from S5	<ul style="list-style-type: none"> ● Disabled: By default, the functions is disabled. ● Fixed Time: You can use the fixed Time menu to modify the wake time. ● Dynamic Time: You can set multithreaded to wake system from S5 after enabling Dynamic Time.

4.2.4 Trusted Computing

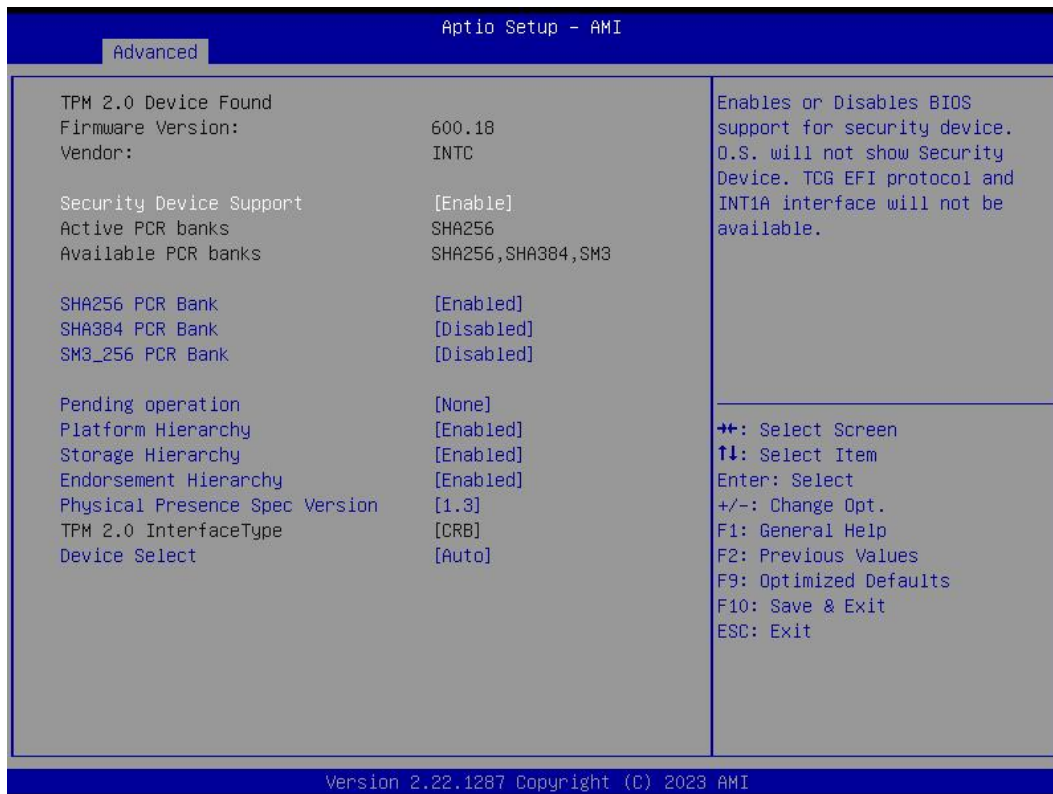
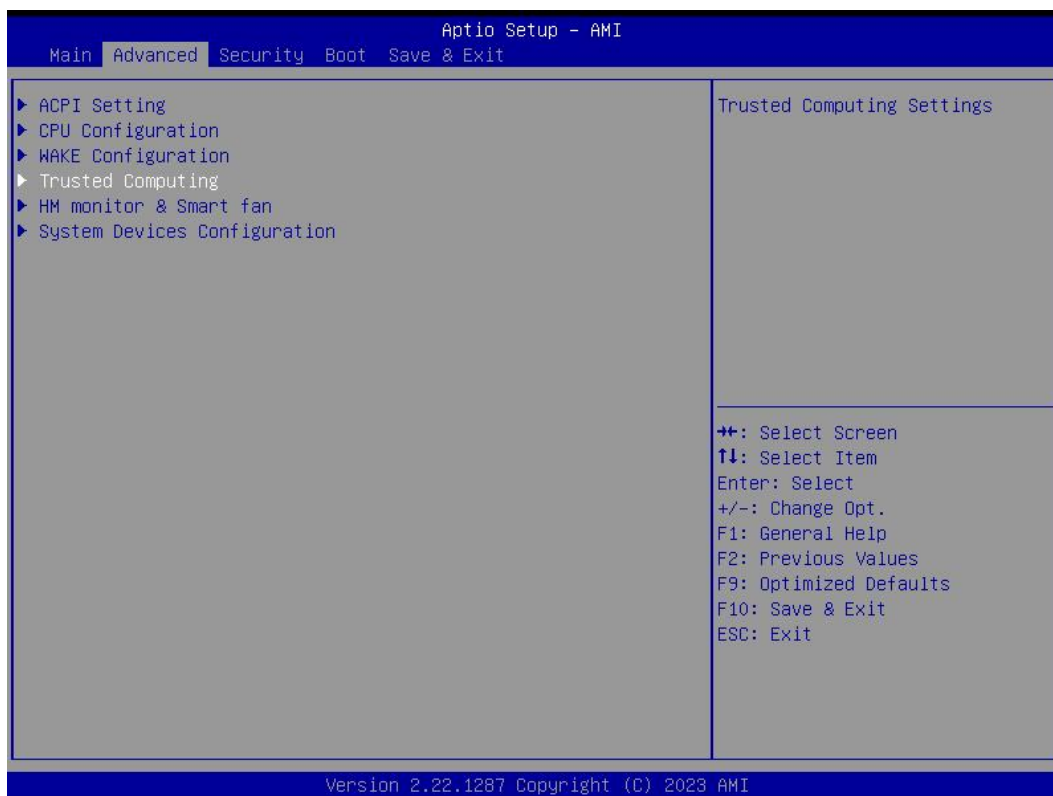

TPM20 Device Found	Description
Firmware Version	<ul style="list-style-type: none">● TPM FW version is 600.18
Vendor	<ul style="list-style-type: none">● The vendor is INTC
Security Device Support	<ul style="list-style-type: none">● Disabled● Enabled. This item is enabled by default.
SHA256 PCR Bank	<ul style="list-style-type: none">● Disabled. This item is Enabled by default● Enabled.
SHA384 PCR Bank	<ul style="list-style-type: none">● Disabled This item is Disabled by default.● Enabled.
SM3_256 PCR Bank	<ul style="list-style-type: none">● Disabled This item is Disabled by default.● Enabled.
Pending operation	<ul style="list-style-type: none">● It includes None and TPM Clear function.
Platform Hierarchy	<ul style="list-style-type: none">● Disable or Enable the Platform Hierarchy.
Storage Hierarchy	<ul style="list-style-type: none">● Disable or Enable the Storage Hierarchy.
Endorsement Hierarchy	<ul style="list-style-type: none">● Disable or Enable the Endorsement Hierarchy.
Physical Presence Spec Version	<ul style="list-style-type: none">● You can choose 1.2 or 1.3. The version is 1.3 by default.
TPM 20 Interface Type	<ul style="list-style-type: none">● TPM2.0 Interface Type is CRB by default.
Device Select	<ul style="list-style-type: none">● You can select TPM1.2 or TPM2.0 or Auto. Auto is set up by default.

4.2.5 HW Monitor & Smart fan

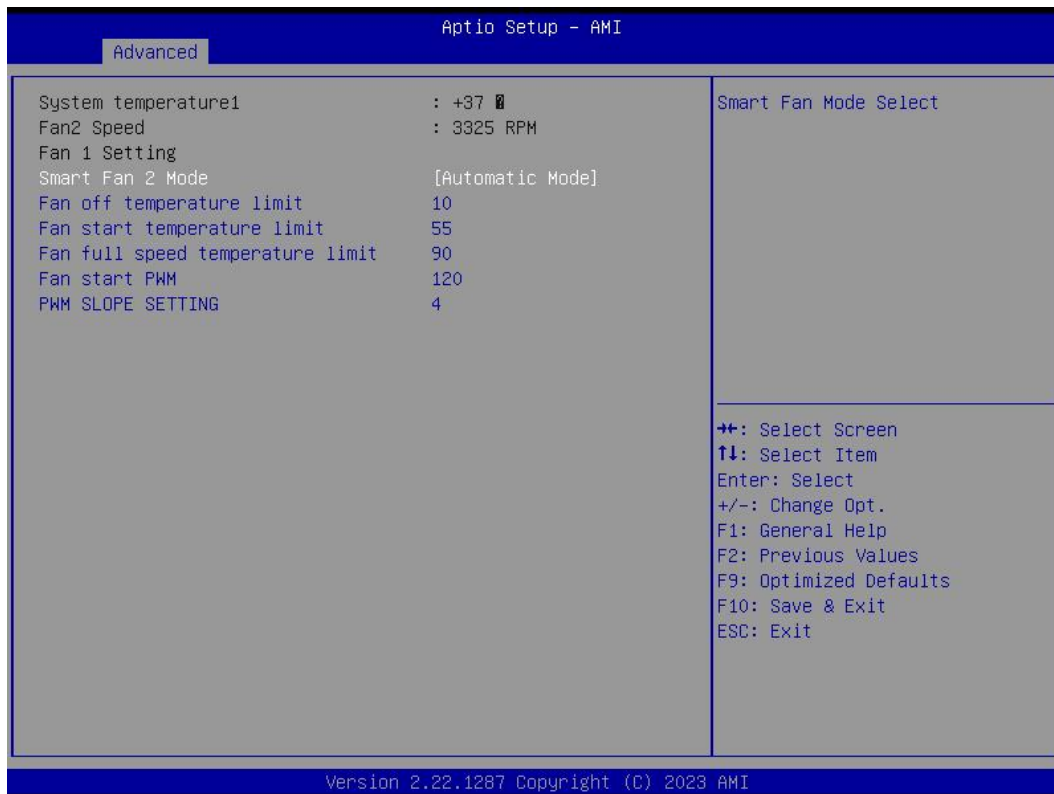
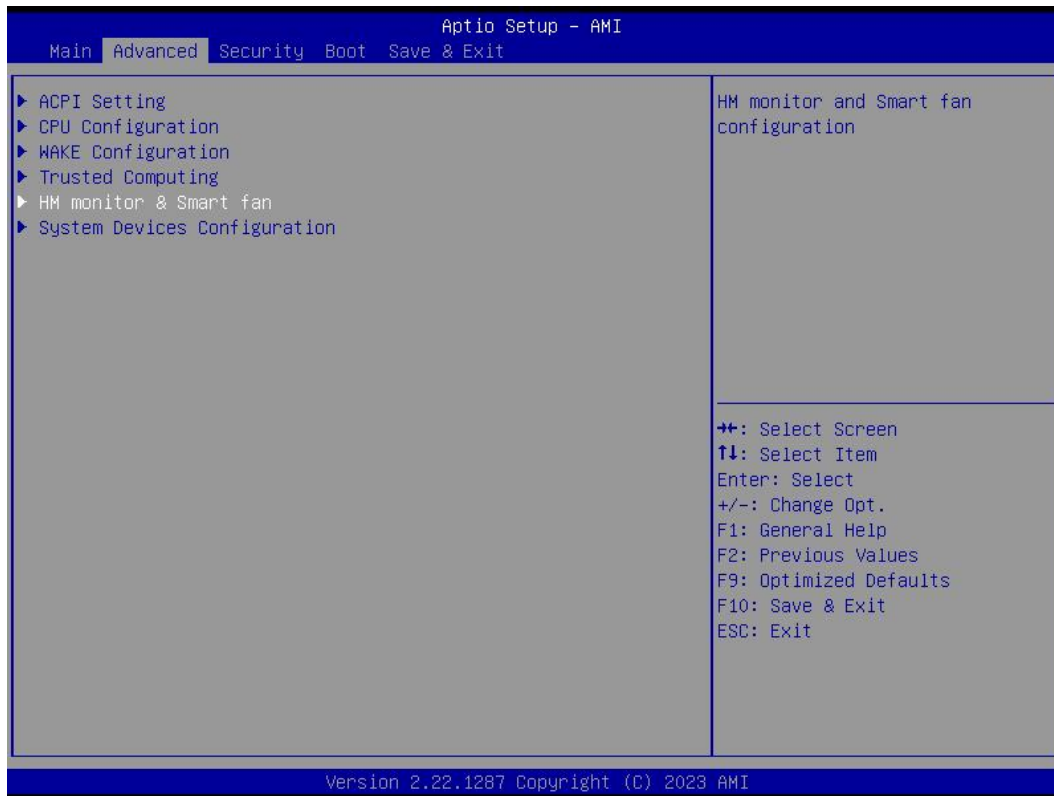

Pc Health Menu	Description
Pc Health Status	
Smart Fan 2 Mode	It includes "Automatic mode" and "software mode". <ul style="list-style-type: none">● Automatic mode. Automatic mode is enabled by default.● Software mode.
Fan off temperature limit	<ul style="list-style-type: none">● FAN will stop work If temperature is lower than the Fan off temperature limit value.
Fan start temperature limit	<ul style="list-style-type: none">● If the temperature is higher than fan off temperature limit, FAN will start work.
Fan Full Speed Temp limit	<ul style="list-style-type: none">● If the temperature is higher than the FAN Full Speed temp limit value, the FAN will work at full speed.
Fan start PWM	<ul style="list-style-type: none">● If the temperature is higher than the FAN start PWM value, the FAN will start work.
PWM slope setting	<ul style="list-style-type: none">● 0.125 PWM● 0.25 PWM● 0.5 PWM● 1 PWM● 2 PWM● 4 PWM● 8 PWM● 15.875 PWM

4.2.6 System Devices Configuration

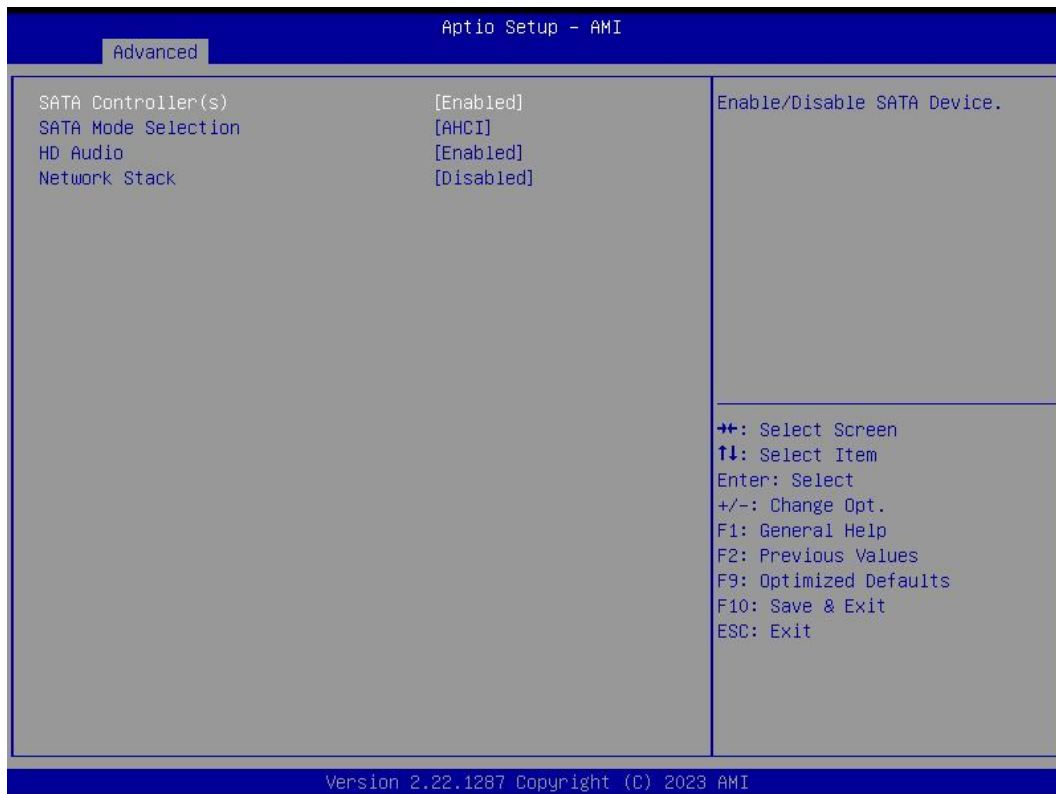
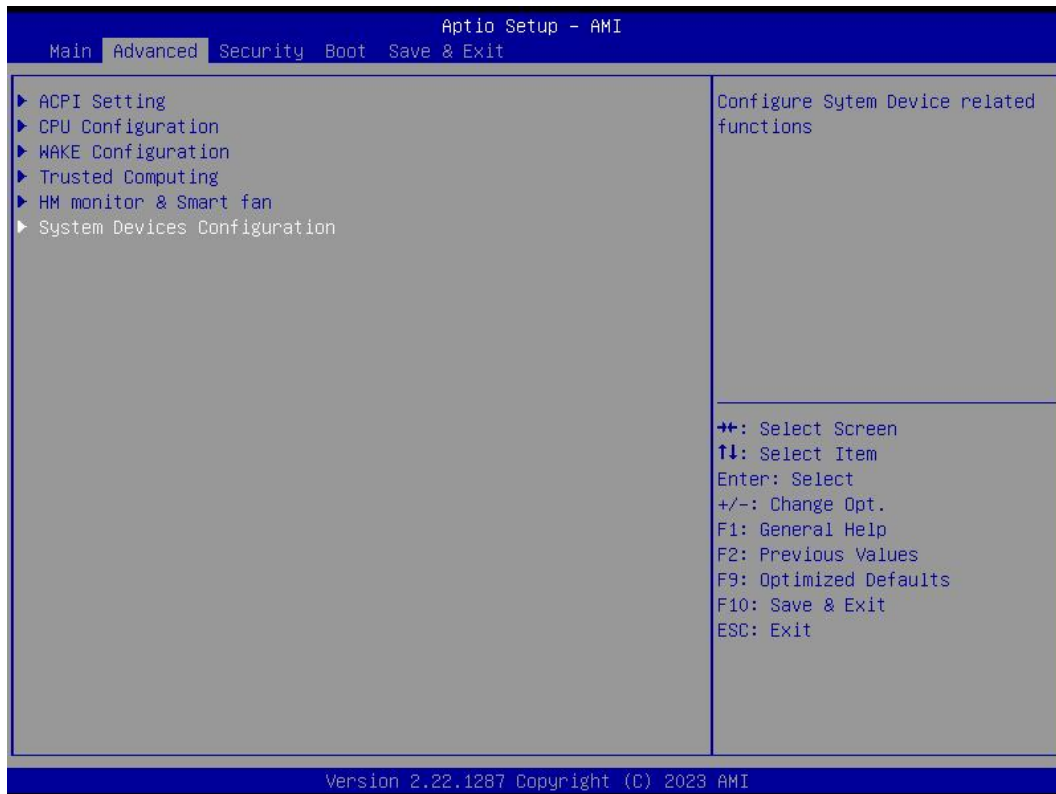

Menu	Description
SATA Controller(s)	<p>The SATA controller is enabled by default.</p> <ul style="list-style-type: none"> ● Enabled ● Disabled.
SATA Mode Selection	<ul style="list-style-type: none"> ● Determines how SATA controller(s) operate.
HD Audio	<ul style="list-style-type: none"> ● Control Detection of the HD-Audio device. ● HAD will be unconditionally disabled when disabled. ● HAD will be unconditionally Enabled when Enabled.
Network Stack	<p>The Network Stack is disabled by default.</p> <ul style="list-style-type: none"> ● Enabled ● Disabled.

4.3 Security Setup (set the administrator/user password)



If this function is selected, the following information will appear:
 Enter New Password hhhhhh

Then enter a password which is no more than eight characters and press <Enter>. BIOS will require to enter the password again.

Once you enter it again, BIOS will save the set password. Once the password item is enabled, you will be required to enter the password every time before the system entering to the setup program of BIOS. The user can set this item through the Security Option in advanced BIOS properties. If the Security Option is set as System, the password will be required to be entered before both the system guides and entering to the setup program of BIOS. If it is set as Setup, the password will be required to be entered only before the system entering to the setup program of BIOS.

To delete the password, press <Enter> in the popped-up window that requires to enter the password. Then information for confirmation will appear on the screen to allow you decide whether the password will be disabled. Once the password is disabled, you can enter the setup program directly without password when the system is restarted.

Boot Sector Virus Protection. This item is used for setting the alarm function in case of virus attack in IDE disk sector. If this item is set as Enable and some program writes information in the sector, BIOS will display alarm information on the screen and buzz.

Security Item	Description
System Mode Configuration	
Secure Boot	Secure Boot feature is Active if Secure Boot is Enabled. Platform key (PK) is enrolled and the System is in user mode. The mode change requires platform reset.
Secure Boot Mode	Secure Boot Mode options includes Standard and Custom mode. In Custom mode, Secure Boot Policy variables can be configured by a physically present user without full authentication.

4.4. Boot Menu

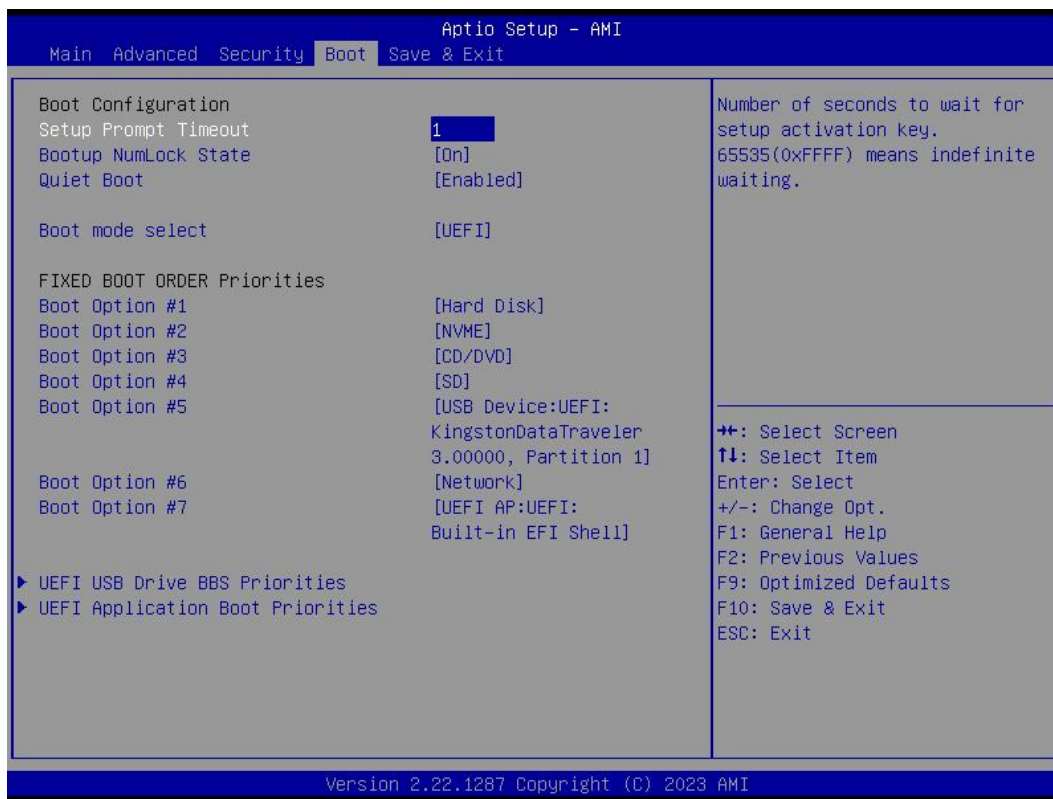

Boot Item	Description
Boot Configuration	
Setup Prompt Timeout	This item is used to set the waiting time of entering the operation system. During the BIOS post, if user doesn't press the keyboard, it won't respond unless you reboot the BIOS. The Setup Prompt Timeout is 3s by default. You can set the time as you want.
Boot up Num Lock State	Options are OFF and ON. In other words, this item can be used to set the state of Num Lock after entering the system. It can be set according to user's needs and doesn't affect the performance of the computer.
Quiet Boot	If this item is set as Enabled, the system can be started within five seconds and some detection items will be ignored. The options are [Disabled] and [Enabled].
FIXED BOOT ORDER Priorities	
Boot Option #1	The first boot device. If BIOS doesn't detect the first boot device, it will check the second boot device.
Boot Option #2	The second boot device.

Boot Item	Description
Boot Option #3	The third boot device.
Boot Option #4	The fourth boot device.
Boot Option #5	The fifth boot device.
Boot Option #6	The sixth boot device.
Boot Option #7	The seventh boot device.
UEFI USB Drive BBS Priorities	You can set and management UEFI USB device after enabling this option.
UEFI Application Boot Priorities	You can set and management UEFI hard disk after enabling this option.

4.5 Save&Exit

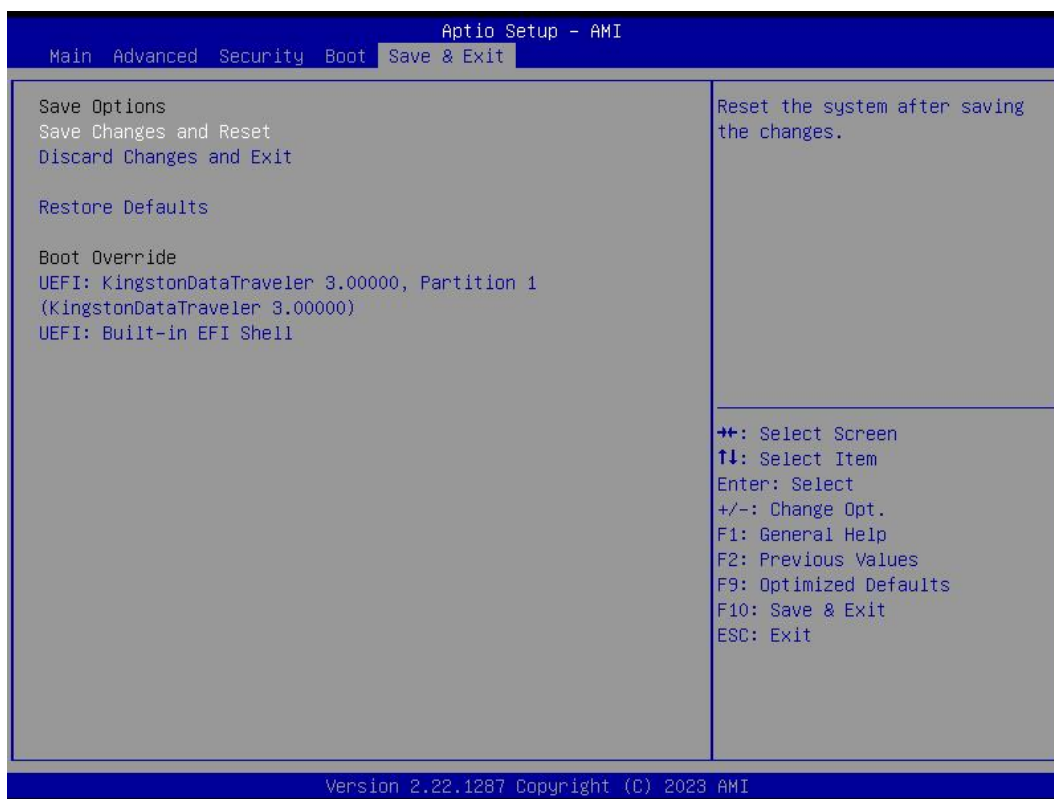

Save Exit Item	Description
Save Options	
Save Changes and Reset	Save all changes and exit

Save Exit Item	Description
Discard Changes and Reset	Give up the settings and exit.
Restore Defaults	Recover it to default.
Boot Override	Whole Boot devices

5. JAHC Introduction

JEHE Active Hardware Control (JAHC) management system includes both hardware Micro Control Unit (MCU) and software (JAHC Technology Manager). It can support following functions:

1. Automatically boot up when power on. It is controlled by the Micro Control Unit (MCU) chip.
2. Real Timer Controller (RTC) wake up: user can install the JAHC software to set up automatic startup and shutdown, one week as a circle.
3. Watchdog timer. It is a built-in API interface.
4. Infrared remote control (Optional IR controller).

5.1 How to set up Auto power on function

Automatically reboot when power on

The function of automatically reboot when power on is controlled by hardware. You can enable it by switching the JAHC button to “on”.

If you cannot find the physical switch on the player, then you can go into the BIOS to enable it by following steps:

- a. Turn on the player and continually press ‘Del’, then it can enter BIOS setup menu.

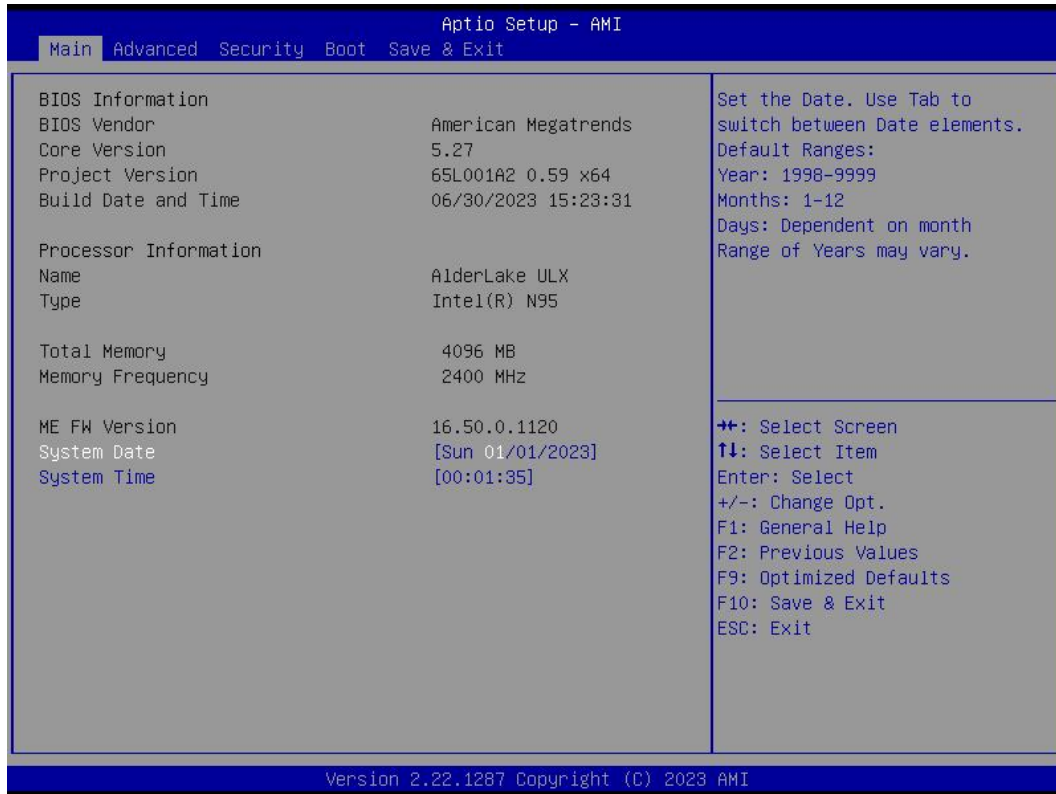

b. Select Advanced- > ACPI Setting- > JAHC Enable- > Enabled.

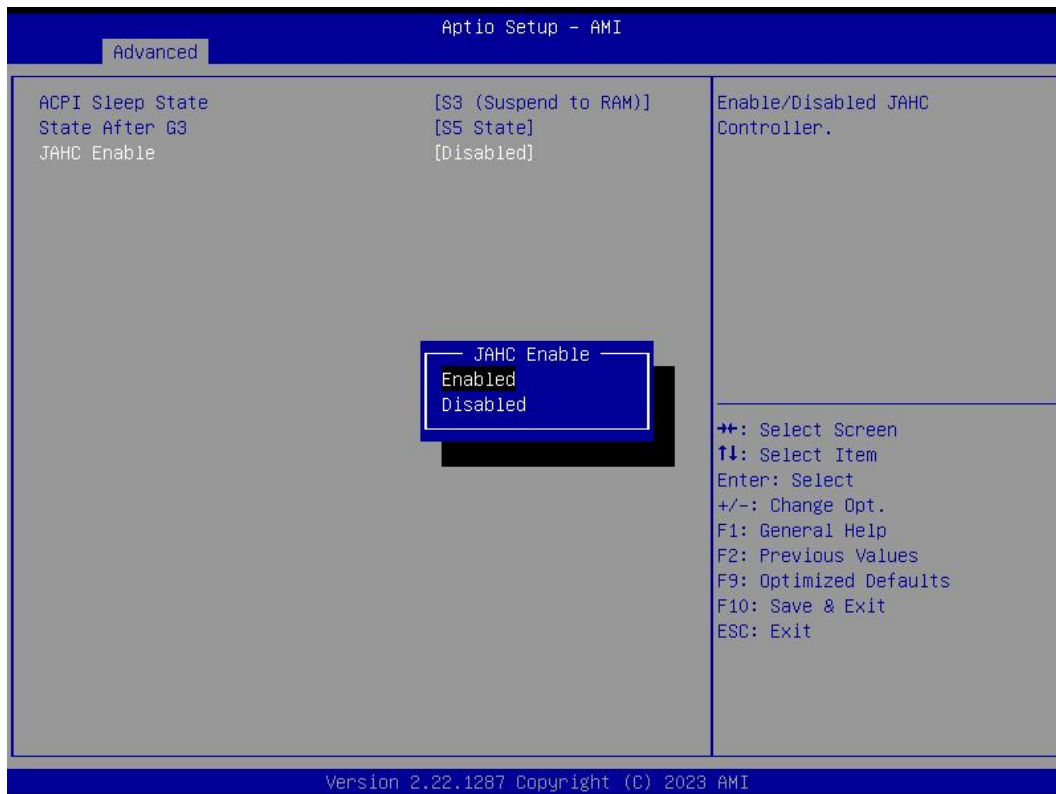

c. Press 'F10' to save change & exit after select "JAHC enabled" option.

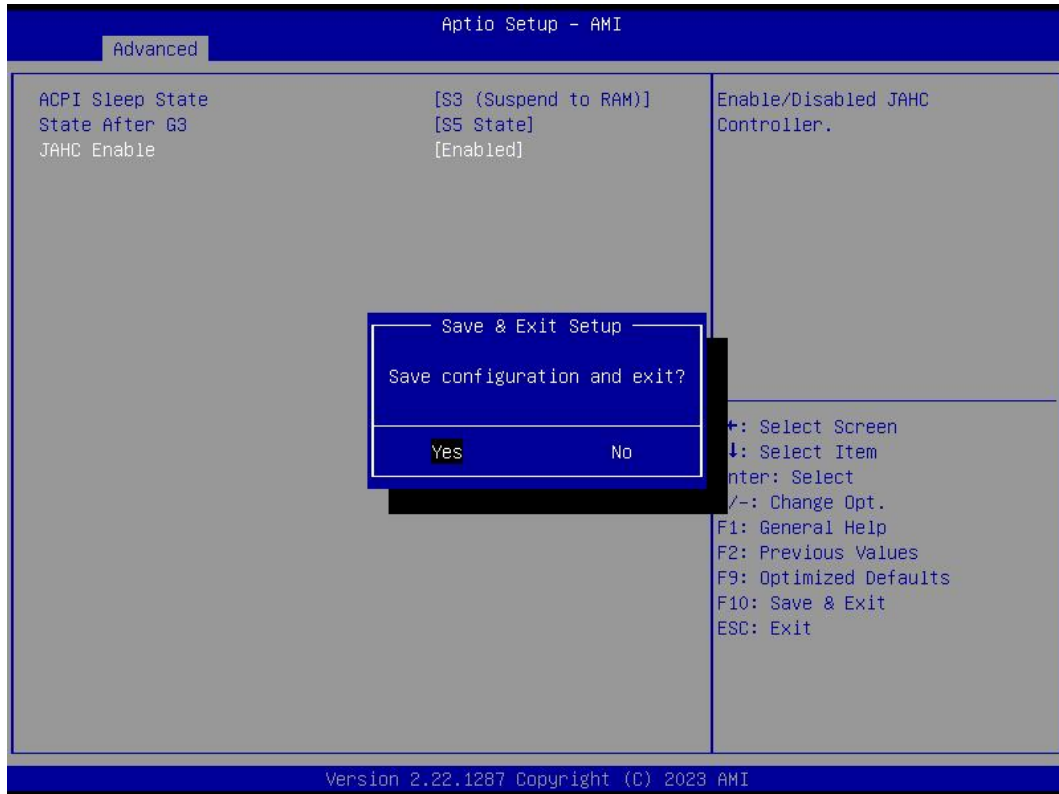

5.2 JAHC software

5.2.1 JAHC software functions

- RTC wake up. The user can set up automatic startup and shutdown, one week as a circle
- Caution message prior to shutdown to remind user to save the data. User can also choose to postpone the shutdown process.
- When JAHC is running, it can support reboot automatically when system is crashed. No additional settings needed.

5.2.2 JAHC software installation guide

System Requirements:

- Giada player with JAHC function.
- Switch the JAHC button to “on” or enable it in BIOS if there is no physical button on the chassis.
- Supported operation system: Windows 10 64bit, Linux 64bit.

How to install JAHC software:

Please download the JAHC.EXE from Giada DVD, then follow up below steps:

- Double-click the JAHC.EXE file, the setup wizard will pop up, select destination location and click [Next] button to continue the installation.

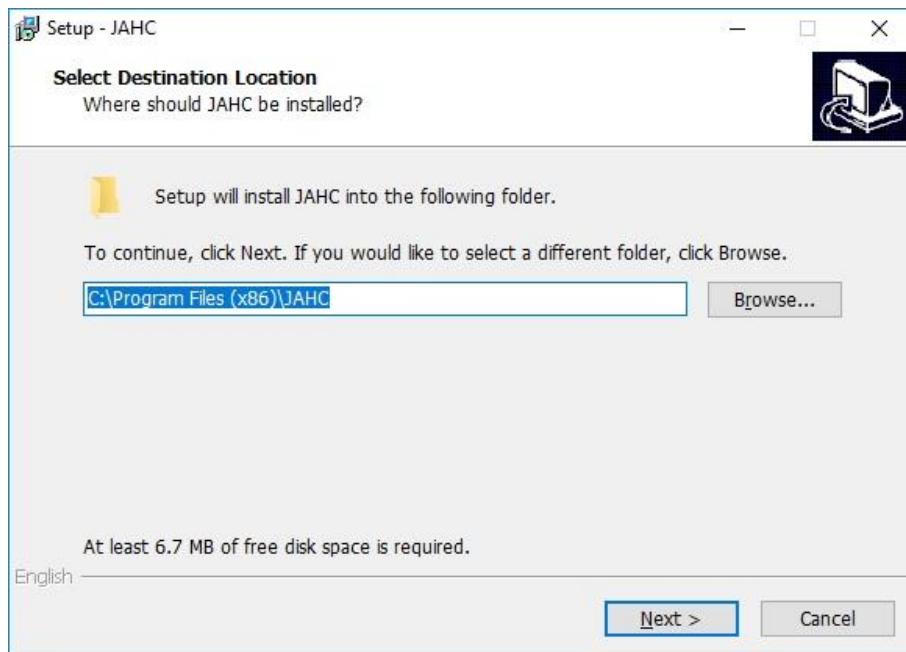

b. Click [Next] button to continue the installation.

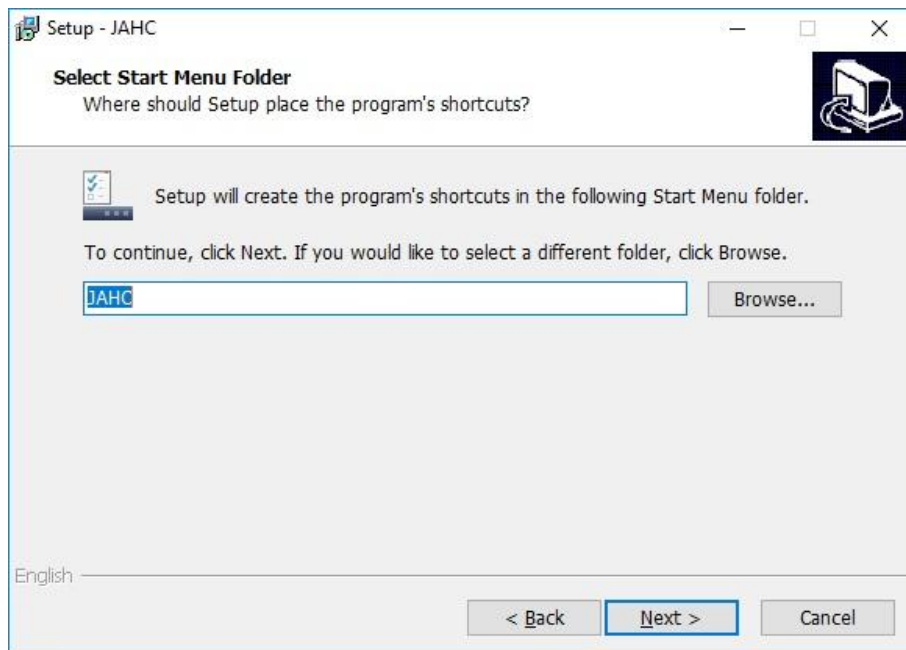

c. Select [Create a desktop shortcut] and click [Next] button.

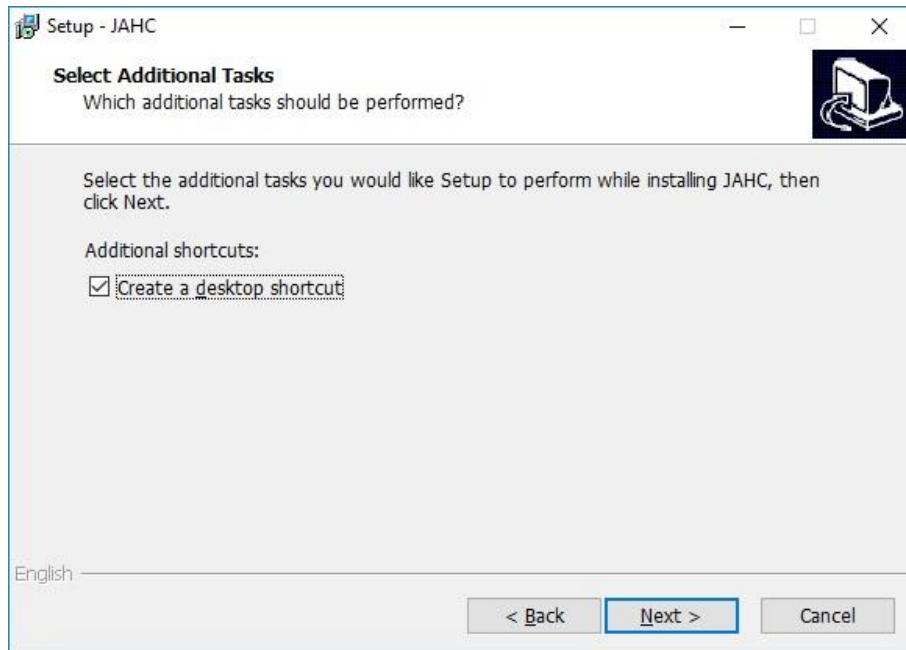

d. Click [Install] button to continue the installation.

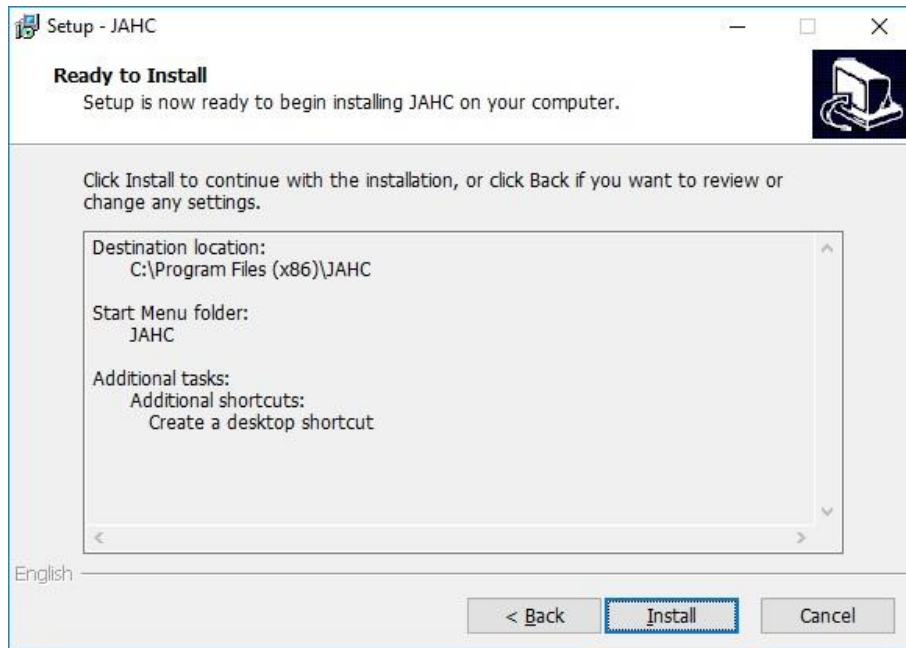

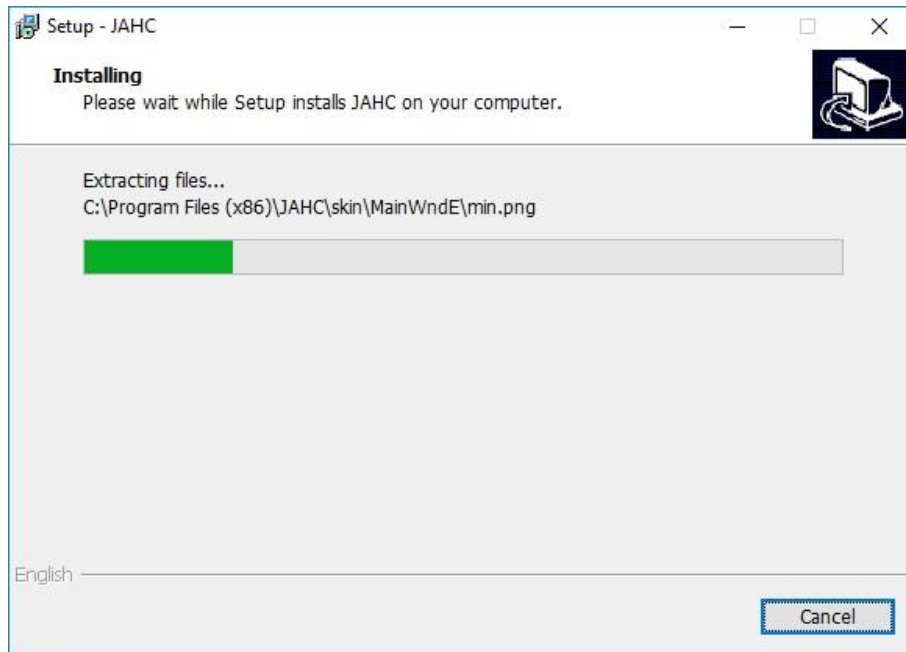

e. Click [Finish] button to finish the installation. You can select [Launch JAHC] to run the software automatically after finishing the installation.



Notice: The JAHC will be added into boot item when it is installed. It will start up when system boot up.

5.2.3 Startup & shutdown time setup

After install the JAHC software, double click the JAHC icon on taskbar and the setup menu will pop up.



One week as a circle, maximum 3 schedules per day. Select each schedule to set up the resume time and shutdown time. Click [Confirm] button to launch the schedule.



After finishing the setup, the menu window will notice the resume time and shutdown time.

▲ Caution: If the interval from shutdown time to next resume time is less than 3 minutes, the system will not shut down.

Click [Cancel] button to restore the time settings and cancel the shutdown status.

Click [X] button to hide the menu. You can find it on taskbar.

Right click the JAHC icon on taskbar and select [exit] to exit the software.

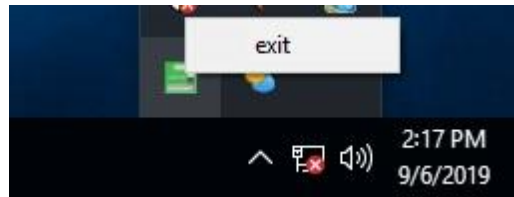

Shutdown caution: the shutdown caution will pop up before the system shutdown.

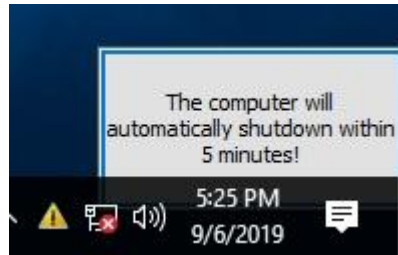

You can double click the message window and a new dialog box will pop up.

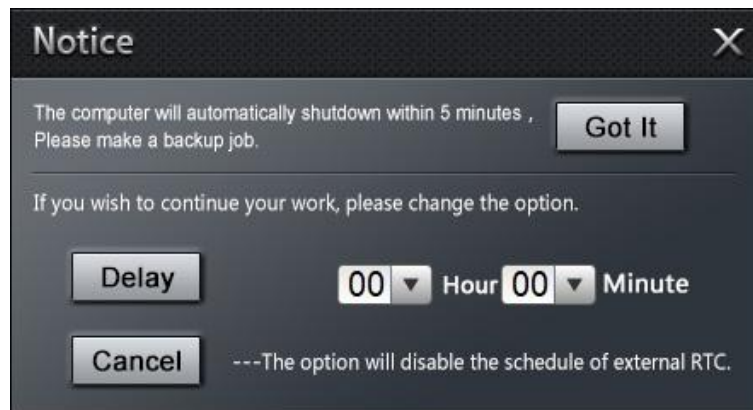

You can click [Delay] button and set up the time to delay the shutdown or click [Cancel] button to cancel the shutdown.

5.3 Watchdog API and instruction

Please contact Giada FAE (email:support@giadatech.com) for watchdog API software and instruction.



Shenzhen JIEHE Technology Development Co., Ltd.

Website: www.giadatech.com

Phone: +86-755-33300336

Email: support@giadatech.com

Address: 1~2/F, Block A, Tsinghua Information Harbor, North Section,
Shenzhen Hi-tech Park, Nanshan District, Shenzhen, China



The terms HDMI, HDMI High-Definition Multimedia Interface, and the HDMI Logo are trademarks or registered trademarks of HDMI Licensing Administrator, Inc.